



# LIFTWATCH 5 LOAD ON HOOK RATED CAPACITY INDICATOR

Operators Guide





This guide describes operation of the  
PROLEC LIFTWATCH 5 LOAD ON HOOK RATED CAPACITY INDICATOR FOR EXCAVATORS

Model covered :      MODEL Ref                      LIFTWATCH 5 EXCAVATOR RCI SYSTEM  
                                 PART No.                                      002022-000

Prolec supports a nationwide network of fully trained service engineers. Warranty claims, service work, technical information and spare parts are available by contacting :

Prolec Ltd  
25 Benson Road  
Nuffield Industrial Estate  
Poole Dorset BH17 0GB

Telephone      +44 (0) 1202 681190  
Fax                +44 (0) 1202 677909  
E-mail            service@prolec.co.uk

DURING NORMAL OPERATION THE SWL OF A CRANE SHOULD NOT BE EXCEEDED. THEREFORE THE WARNING OF OVERLOAD SHOULD NOT BE USED AS A NORMAL OPERATING FACILITY. IT SHOULD BE NOTED THAT CERTAIN STATUTORY REQUIREMENTS DO NOT PERMIT THE SAFE WORKING LOAD TO BE EXCEEDED EXCEPT FOR THE PURPOSE OF TESTING.

**THIS RCI IS NOT SUITABLE FOR USE IN EXPLOSIVE ATMOSPHERES. ADJUSTMENT BY UNAUTHORISED PERSONS WILL INVALIDATE ANY WARRANTY OR CERTIFICATION SUPPLIED. IF A PROBLEM ARISES WHICH CANNOT BE RECTIFIED USING THIS GUIDE, AUTHORISED SERVICE SHOULD BE SOUGHT.**

THIS DEVICE IS CERTIFIED TO MEET CURRENT UK & EC SAFETY REGULATIONS FOR EXCAVATORS USED AS CRANES.

Any alterations or modifications to machine components which affect this system must be reported to Prolec Ltd or via the machine convertor/ service agreement holder.

Prolec Ltd must be informed of any Prolec system component failure. Be it directly or via the machine convertor/service agreement holder. Manufacturers original instructions.

**CONTENTS**

<b>Section</b>	<b>Subject</b>	<b>Page</b>
<b>1</b>	System Components	<b>6</b>
<b>2</b>	Power On	<b>7</b>
<b>3</b>	Initialisation	<b>7</b>
<b>4</b>	Mode Sequence	<b>8</b>
<b>5</b>	Time & Date	<b>11</b>
<b>6</b>	Rated Capacity Indicator Mode	<b>12</b>
<b>7</b>	Rated Capacity Indicator Only Mode (Key Switch Only)	<b>14</b>
<b>8</b>	Slew Limiting Mode	<b>15</b>
<b>9</b>	Height Indication Modes	<b>17</b>
<b>10</b>	Max radius Limitation Mode	<b>21</b>
<b>11</b>	Minimum (Cab Protection) Radius Limitation Mode	<b>23</b>
<b>12</b>	Duty Selection Mode	<b>25</b>
<b>13</b>	Dig Depth Monitoring Mode	<b>26</b>
<b>14</b>	System Test	<b>28</b>
<b>15</b>	Setting the Clock	<b>31</b>

**CONTENTS**

<b>Section</b>	<b>Subject</b>	<b>Page</b>
<b>16</b>	Setting Screen Contrast	<b>32</b>
<b>17</b>	Error Conditions	<b>33</b>
<b>18</b>	System Diagrams	<b>34</b>
<b>19</b>	Daily Checks	<b>37</b>

## 1 System Components

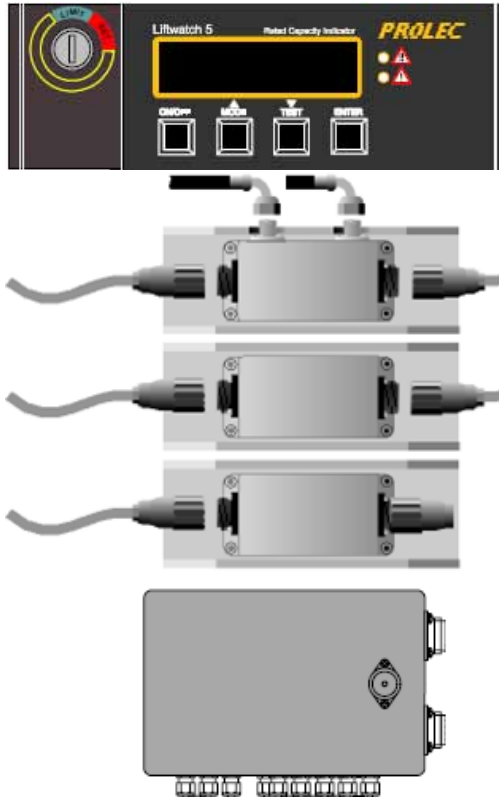

Cab mounted combined computer/LCD display unit. Rear mounting plate carries sockets for connection to DC power and the monoboom or primary boom angle sensor. Shown here with optional key switch. The key switch has two positions - LIMIT and SET.

Combined boom angle sensor (or primary boom sensor on hydraulically adjustable booms) and two 500bar pressure transducers connected via ¼ BSP hose to the boom cylinder hose burst protection valve(s). This sensor is usually mounted on the OFFSIDE of the boom. The left electrical plug is connected to the in cab display and the right plug to either the arm sensor on monoboom machines, or the secondary boom sensor on hydraulically adjustable booms.

[OPTIONAL] Secondary boom angle sensor for hydraulically adjustable booms. This sensor is usually mounted on the OFFSIDE of the secondary boom. The left plug is connected to the primary boom sensor and the right plug to the arm sensor.

Arm angle sensor usually mounted on the NEAR SIDE of the arm near the pivot pin. The left plug is connected to either the boom sensor or the secondary boom sensor, dependant on system configuration. The right socket has a special 'Terminator' plug fitted. This is required for correct system operation.

[OPTIONAL] Combined slew and relay unit (Combi Box) for control of hydraulic solenoid valves, and electrical inputs for automatic duty switching (8 duties). This unit also connects to an external alarm. Contact Prolec for connection details.

[OPTIONAL] Single relay unit (Single Motion Cut Box) for control of hydraulic solenoid valve for height limitation on Boom only, and electrical inputs for automatic duty switching (2 duties only). This unit also connects to an external alarm. Contact Prolec for connection details.

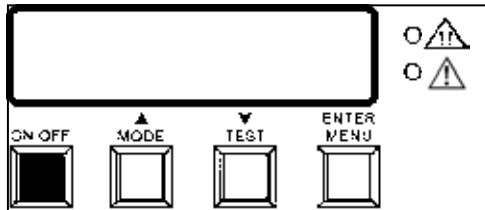

## 2 Power On

The Liftwatch 5 system will only operate when it is switched on. Until switch-on, the display will be blank and none of the visual or audible warnings will operate. The basic system offers three modes of operation :

- Rated Capacity Indicator for excavator lifting operations
- Basic dig depth monitoring
- Automatic true height indication

To activate the Liftwatch 5 press the ON button

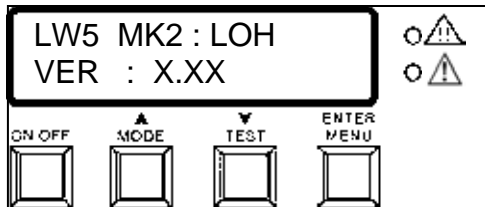

## 3 Initialisation

Once activated, Liftwatch 5 will perform an initialisation procedure. This can take three to four seconds, during which time all sensors and auxiliary components are checked for correct operation. If all checks are successfully completed, operation will commence. If problems are detected during initialisation a relevant warning message will be issued.

Refer to section 17 for further information on error conditions.

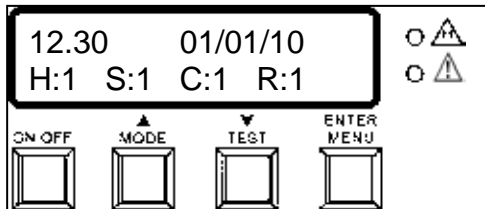

After successful initialisation, the system will enter TIME/DATE mode (See section 5). If any activated mode has been previously set with a valid limit, then a active indicator will be displayed on all set modes (See section 4).

## 4 Mode Sequence

### 4.1 Mode Sequence (No Key Switch Fitted)

#### TIME/DATE

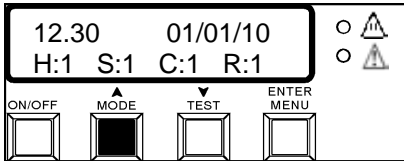

#### RCI



#### \*SET HEIGHT LIMIT

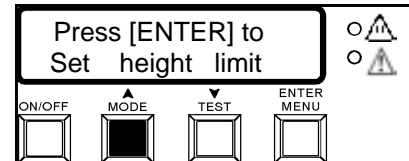

#### DEPTH MONITOR

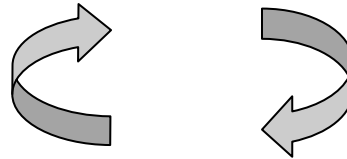
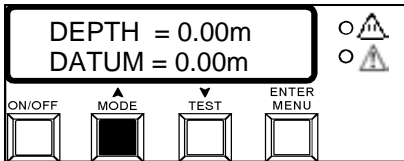

#### \*SET SLEW LIMITS

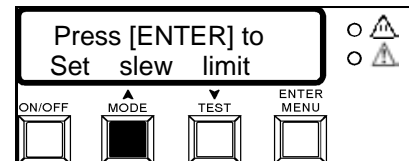

#### \*SELECT DUTY

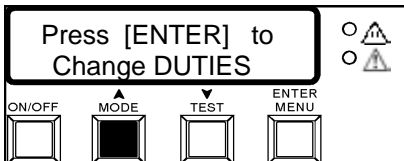

#### \*SET MIN RADIUS LIMIT

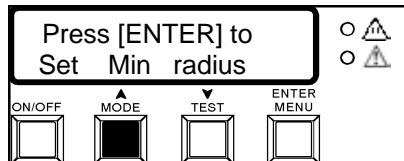

#### \*SET MAX RADIUS LIMIT

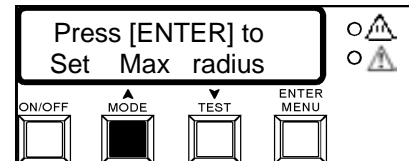

Pressing the MODE button will cycle the Liftwatch 5 through the eight available operational modes as shown above. Each mode is individually described in the following sections. If a key switch is fitted, see next two sections.

\* Optional, may not be activated at installation.



## 4 Mode Sequence Continued

### 4.2 Mode Sequence (Key Switch Fitted and in the SET Position)

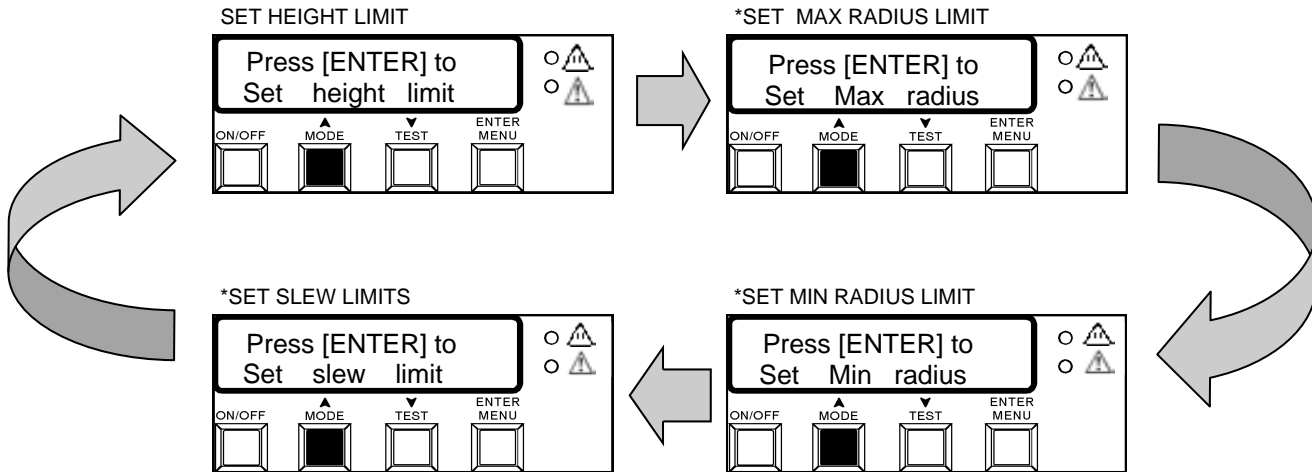

With the key switch in the SET position, pressing the MODE button will cycle the Liftwatch 5 through the four available operational modes as shown above, if activated. Turning the key switch to the SET position will automatically select the Set Height Limit mode. Each mode is individually described in the following sections.

\* Optional, may not be activated at installation.

## 4 Mode Sequence Continued

### 4.3 Mode Sequence (Key Switch Fitted and in the LIMIT Position)

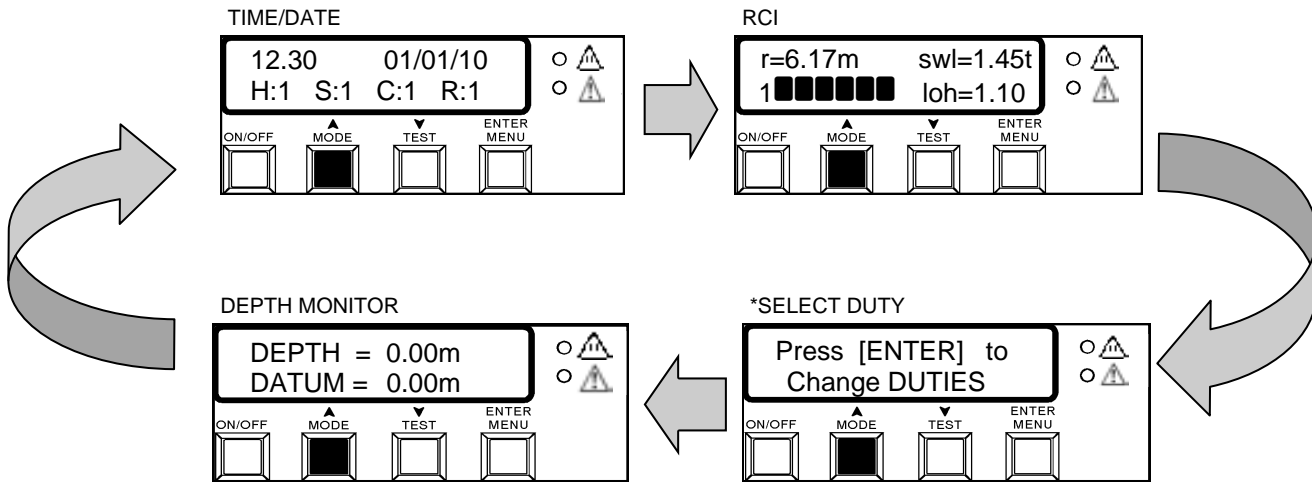

Turning the key switch to LIMIT position will automatically return the Liftwatch 5 to the last mode selected from the available modes above. Pressing the MODE button will cycle the Liftwatch 5 through the four available operational modes, if activated. Each mode is individually described in the following sections.

\* Optional, may not be activated at installation.

## 5 Time/ Date Mode

Time /date mode shows the current time and date. In this mode, the Rated Capacity Indicator and dig depth functions are not operating.

The status of Height limiting, Slew limiting, Cab Protection (Min Radius limiting) and Max Radius limiting are displayed on the lower line. If a mode has not been activated at calibration, its mode character will not be displayed.

To indicate the status of an activated limit, clock mode displays a character and its state for the following functions:

Height limiting	H = n
Slew limiting	S = n
Cab Protection	C = n (Min Radius limiting)
Max Radius limiting	R = n

n =1 (ON) and n = 0 (OFF).

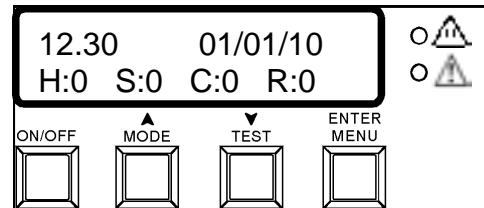
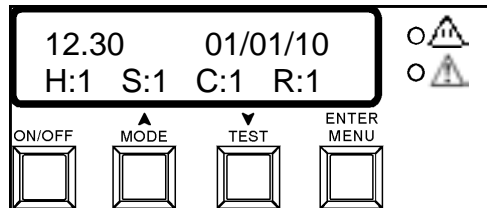

## 6 Rated Capacity Indicator Mode

In the RCI MODE, the upper line displays the current bucket pin radius and the maximum safe working load at that radius. The lower line shows the bar graph will indicate the proximity of the current load to the maximum available safe working load and the current Load on Hook. Approach to SWL and OVERLOAD are indicated by audible and visual indicators.

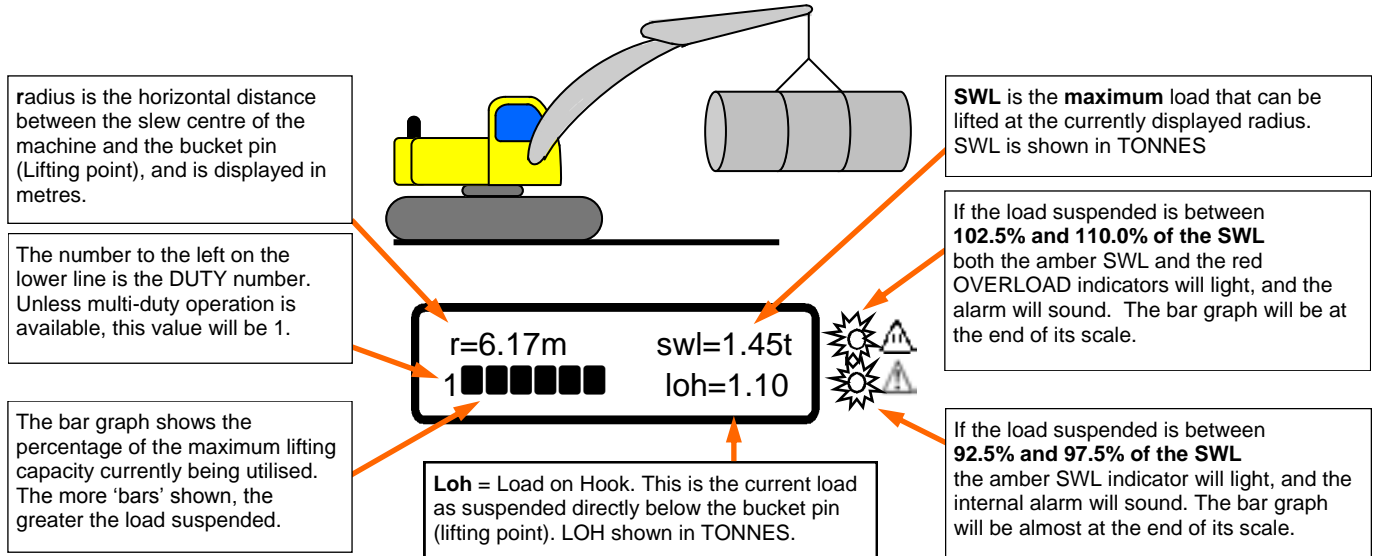

**The SWL as displayed assumes that the load is suspended directly below the bucket pin (lifting point). The weight of the bucket, if fitted, and any lifting devices, (e.g. a quick hitch) must be deducted from this value. The bucket cylinder and control linkage is assumed to be present.**

Any alterations or modifications to machine components which affect the RCI must be reported to Prolec Ltd or via the machine convertor/service agreement holder.

## 6 Rated Capacity Indicator Mode Continued

During operation in the rated capacity indicator mode, three further messages can appear on the display. Each of these conditions will illuminate the red OVERLOAD led and will sound a warning alarm. The message/alarm will persist until either the condition returns to its correct state, the system is switched off, or the mode is changed.

r=6.17m      1.45t  
! HYDRAULIC LIMIT



### 6.1 Hydraulic limit

The hydraulic limit message can indicate either that the current pressure measured in the boom lift rams is in excess of 87% of MRV (Main Relief Valve) pressure, or there is a failure in the system pressure transducer. The hydraulic limit message normally only occurs at short radii (where the SWL of the machine is limited by hydraulic capacity rather than machine stability), or if the boom cylinders are powered at the end of their stroke. During both these circumstances the MRV should be heard to be 'blowing'. If this message appears at any other time then there is likely to be a problem with the pressure transducer, and service should be sought.

r=6.17m      1.45t  
! LOW PRESSURE



### 6.2 Low Pressure

The low pressure warning is similar to 6.1 above, it can indicate either a system state, or a system error. If the pressure measured in the boom lift cylinders falls below 5 bars then this message will be issued. This normally occurs if the machine equipment is either rested on, or powered into the ground. If this message occurs at any other time then there is likely to be a problem with the pressure transducer, and service should be sought.

r=6.17m      1.45t  
! OVERLOAD



### 6.3 Overload

The OVERLOAD message is displayed, both the amber SWL and the red OVERLOAD indicators will light, and the internal and external alarm will sound when the machine has reached its maximum safe working load. If fitted, motion cut will occur disabling boom up, boom down, artic up, artic down and arm out.

Maximum safe working load is between **102.5% and 110.0% of the SWL.**

## **7 Rated Capacity Indicator Only Mode (Key Switch Only)**

### Key switch in the LIMIT position

RCI mode (See section 6) and Select Duty mode (If activated, see section 12) are the only two possible modes available when the key switch is in the LIMIT position. If a limit or limits have been set, the system will monitor and alarm but any set limits cannot be adjusted or cancelled.

Max and Min Radius limits, if activated, can be overridden if the limits are reached but not be cancelled (See sections 10 and 11).

Turning the key switch to the LIMIT position will automatically return the Liftwatch 5 to the last mode in use.

### Key switch in the SET position

Slew Limiting, Height limiting, Max Radius limiting and Min Radius limiting (See following sections), if activated, can be accessed with the key switch in the SET position. Turning the key switch to the SET position will automatically select the Set Height Limit mode.

## 8 Slew Limiting Mode

The slew limitation mode allows either the adjustment of the maximum angular slew both clockwise and anti-clockwise, or the cancelling of the slew limitation function. The Liftwatch 5 system, via the COMBI BOX, allows a direct interface to hydraulic solenoid valves on the pilot control circuits to physically prevent a slew limit from being exceeded. The slew limits are stored in the memory each time they are set. When the system is switched on, the last slew limit values stored will become operative. The status of slew is indicated on the Time/ Date mode (See section 5).

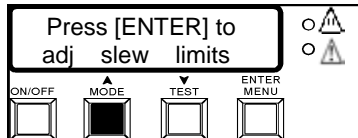

### 8.1 Setting a slew limits

Set the key switch to the SET position (If fitted). Use the mode button to cycle through the available modes until the 'adjust slew limits' is displayed. Pressing ENTER will allow adjustment and cancelling of the slew limiting function. Pressing MODE will continue the mode cycle, leaving the current setting unaltered.

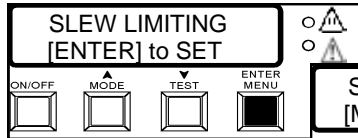

Press the ENTER button to set the limits.

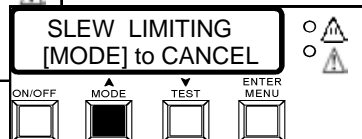

Press the MODE button to cancel the current slew limits.

Set the key switch to the LIMIT position to enable limit (If fitted).

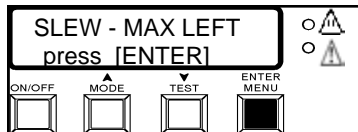

**8.2** Slew the machine to new maximum LEFT (anti-clockwise) limit, and press ENTER. Confirmation of the set angle will be shown until ENTER button has been released.

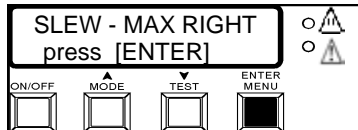

**8.3** Slew the machine to new maximum RIGHT (clockwise) limit, and press ENTER. Confirmation of the set angle will be shown until ENTER button has been released. Set the key switch to the LIMIT position to enable limit (If fitted).

Important: Confirm that alarms activate and motions cut (If fitted) as required before proceeding.

## 8 Slew Limiting Mode Continued

### 8.4 Slew Limits Alarm State

If either limit is reached, the alarm will be activated and movement will be cut. The machine can only slew away from the limit. The limit cannot be overridden and so must be deactivated to allow movement past the set limits. The LW5 screen will display the following message when a limit is reached:

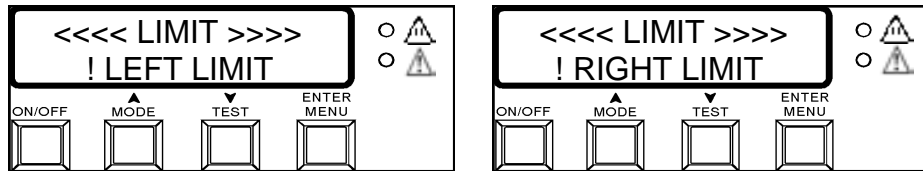

Important: Confirm that alarms activate and motions cut (if fitted) as required before proceeding.



## 9 Height Indication Modes

### 9.1 Basic System or with a Combi Box Fitted

The Height Indication mode allows either the adjustment of the maximum permissible operating height, or the cancelling of the height indication function. The basic Liftwatch 5 system features a 'visual and audible warning only' height indicator. The optional Combi Box (See section 1) allows the system to interface with hydraulic solenoid valves on the pilot control circuits to physically prevent a height limit from being exceeded. The height limit is stored in the memory each time it is set. When the system is switched on, the last height limit stored will become operative. The status of height indication is shown in the Time/ Date mode (See section 5).

The height displayed on the screen represents the current highest part of the equipment. The LW5 system monitors dipper pivot pin and bucket pivot pin heights on monoboam machines, and centre artic pin, dipper pivot pin and bucket pivot pin on machines with hydraulically adjustable booms.

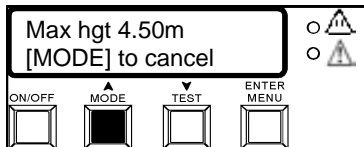
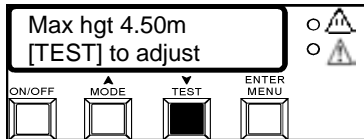
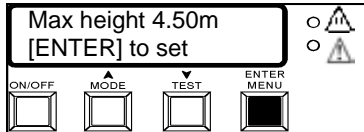
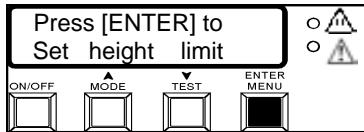

#### 9.11 Setting a height limit

Set the key switch to the SET position (If fitted). Use the mode button to cycle through the available modes until the 'set height limit' is displayed. Pressing ENTER will allow adjustment or cancellation of the height limiting function. Pressing MODE will continue the mode cycle, leaving the current setting unaltered.

If ENTER is pressed, the three alternating displays shown below will appear.

#### 9.12 Adjusting the height limit

To set a new height limit, move the equipment to the desired new maximum height and press ENTER. Set the key switch to the LIMIT position to enable limit (If fitted).

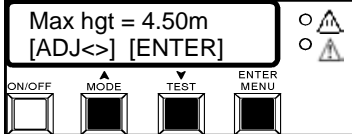

#### 9.13 Adjusting the height limit manually

The maximum height can also be entered manually by pressing TEST, use the arrow buttons to select the desired value and press enter.

Set the key switch to the LIMIT position to enable limit (If fitted).

#### 9.14 Cancelling the height limit

Press the MODE button to cancel the current height limit. Set the key switch to the LIMIT position to enable limit (If fitted).

**Important:** After setting height limit, confirm that alarms activate and motions cut (If fitted) as required before proceeding.

## 9 Height Indication Modes

### 9.2 Single Motion Cut Box Fitted

The Height Indication mode allows either the adjustment of the maximum permissible operating height, or the cancelling of the height indication function. The optional single MOTION CUT (See section 1) allows the system to interface with hydraulic solenoid valve on the pilot control circuit for the Boom Up only to physically prevent a height limit from being exceeded. The height limit is stored in the memory each time it is set. When the system is switched on, the last height limit value stored will become operative. The status of height indication is shown in the Time/ Date mode (See section 5).

\*A Single Motion Cut Box will only be fitted to a mono boom machine, and the dipper pivot pin is the only position monitored. The height limit must be set with all the equipment fully extended (See section 9.3).

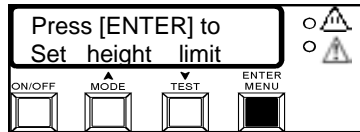

#### 9.21 Setting a height limit

Set the key switch to the SET position (If fitted). Use the mode button to cycle through the available modes until the 'set height limit' is displayed. Pressing ENTER will allow adjustment or cancellation of the height limiting function. Pressing MODE will continue the mode cycle, leaving the current setting unaltered.

If ENTER is pressed, the two alternating displays shown below will appear.

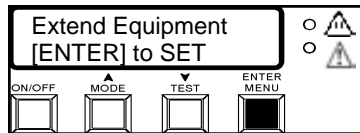

#### 9.22 \*Adjusting the height limit

To set a new height limit, move the equipment to the desired new maximum height and press ENTER.

Set the key switch to the LIMIT position to enable limit (If fitted).

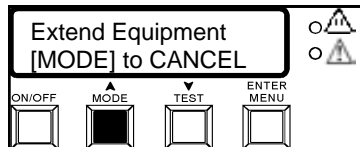

#### 9.23 Cancelling the height limit

Press the MODE button to cancel the current height limit.

Set the key switch to the LIMIT position to enable limit (If fitted).

**Important:** After setting height limit, confirm that alarms activate and motions cut (if fitted) as required before proceeding.

## 9 Height Indication Modes

### 9.3 Setting a height limit with an optional single motion cut

#### Protec Height Limit Operation

##### Important :

This Protec system is fitted with motion cut operation on the Boom only. The Dipper will not stop movement at the alarm limit.

When setting the height limit ensure that the Dipper is fully extended and the bucket moved back to its worst case position before moving the boom to the required height limit.

When the height limit is reached the boom up motion will stop and the in cab display will enter its alarm conditions.

##### Example :

##### Height

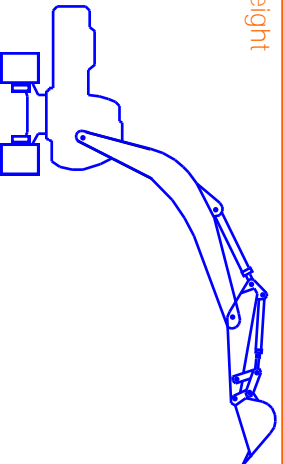

This notice applies to the following Protec products :

- 1 HW/6
- 2 LW/5 with single motion cut option installed

Cab Sticker Part No : 560343-001 Issue 2 

**Important:** After setting height limit, confirm that alarms activate and motions cut (if fitted) as required before proceeding.

## 9 Height Indication Modes Continued

### 9.4 Height Indication Alarm State

If the set height limit is reached, a visual warning and alarm will be activated on a basic system.

If a combi box is fitted, upward and outward motion to the boom, artic and arm can be cut depending on which section has breached the limit.

If a Single Motion Cut Box is fitted, upward motion to the Boom will be cut. Outward motion to the arm is not cut as motion cut is not subjected to this component.

The LW5 screen will display the following message for the section that has reached the limit:

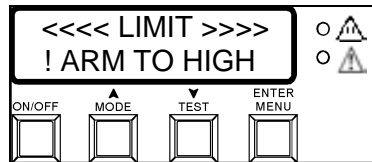

The alarm state will continue until the offending section is 0.5m below the limit.

**Important:** After setting height limit, confirm that alarms activate and motions cut (If fitted) as required before proceeding.

## 10 Max Radius Limitation Mode

The Max Radius Limit mode allows either the adjustment of the maximum permissible operating radius, or the cancelling of the Max radius limit function. The basic Liftwatch 5 system features a 'visual and audible warning only' radius indicator. The optional COMBI BOX (see Liftwatch 5 Hardware Guide) allows the system to interface with hydraulic solenoid valves on the pilot control circuits to physically prevent a radius limit from being exceeded. The Max Radius limit is stored in the memory each time it is set. When the system is switched on, the last Max Radius limit value stored will become operative. The status of Max Radius is shown in the Time/Date mode (See section 5).

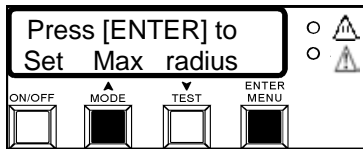

### 10.1 Setting the Max radius Limit

Set the key switch to the SET position (If fitted). Use the mode button to cycle through the available modes until the 'set Max Radius limit' is displayed. Pressing ENTER will allow adjustment or cancellation of the Max Radius limiting function. Pressing MODE will continue the mode cycle, leaving the current setting unaltered.

If ENTER is pressed, the alternating displays shown below will appear.

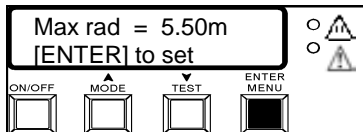

### 10.2 Adjusting the Max Radius Limit

To set a new Max Radius limit, move the equipment to the desired new maximum Radius and press ENTER. The radius displayed on the screen represents the current bucket pin position and does not take into account load dimensions. Set the key switch to the LIMIT position to enable limit (If fitted).

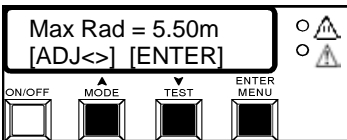
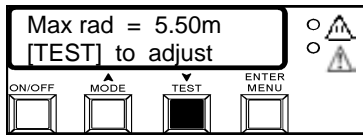

### 10.3 Adjusting the Max Radius Limit manually

To manually enter a radius, press TEST and then use the arrow buttons to set the value. Press ENTER to save.

Set the key switch to the LIMIT position to enable limit (If fitted).

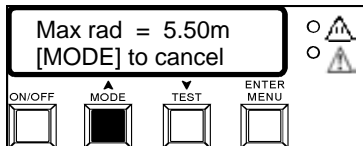

### 10.4 Cancelling the Max Radius limit

Press the MODE button to cancel the current Max Radius limit.

**Confirm that alarms activate and motions cut (If fitted) as required before proceeding.** 21

## 10 Max Radius Limitation Mode Continued

### 10.5 Max Radius limit Alarm State

If the set limit is reached by the bucket pivot pin, a visual warning and alarm will be activated on a basic system. The bucket pivot pin can move through the limit.

With an optional Combi Box fitted, the arm will only move IN. If a Single Motion Cut Box is fitted, no motions will be cut.

The limit can be overridden by pressing MODE. Select YES, confirm selection by pressing ENTER. Pressing YES will allow the bucket pivot pin to be moved past the limit. The alarm will continue to sound and two warning messages will be displayed until the bucket pivot pin is 0.5m inside the limit.

Pressing NO will allow the Radius to be either \*cancelled by pressing YES or return to the normal alarm state by pressing NO.

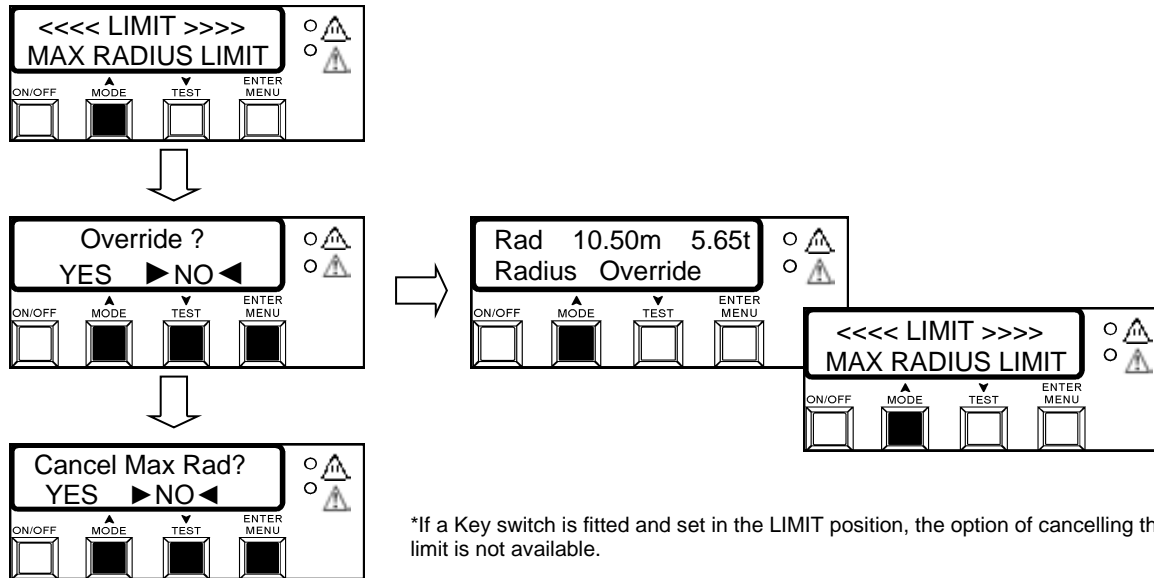

\*If a Key switch is fitted and set in the LIMIT position, the option of cancelling the limit is not available.

## 11 Minimum (Cab Protection) Radius Limitation Mode

The Min Radius Limit mode allows either the adjustment of the minimum permissible operating radius, or the cancelling of the Min radius limit function. The basic Liftwatch 5 system features a 'warning only' radius indicator. The optional COMBI BOX (See section 1) allows the system to interface with hydraulic solenoid valves on the pilot control circuits to physically prevent a radius limit from being exceeded. The Min Radius limit is stored in the memory each time it is set. When the system is switched on, the last Min Radius limit value stored will become operative. The status of Max Radius is shown in the Time/ Date mode (See section 5)

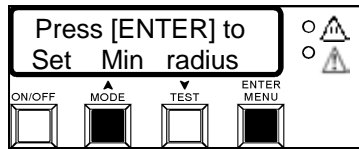

### 11.1 Setting the Min radius Limit

Set the key switch to the SET position (If fitted). Use the mode button to cycle through the available modes until the 'set Min Radius limit' is displayed. Pressing ENTER will allow adjustment or cancellation of the Min Radius function. Pressing MODE will continue the mode cycle, leaving the current setting unaltered. If ENTER is pressed, the alternating displays shown below will appear.

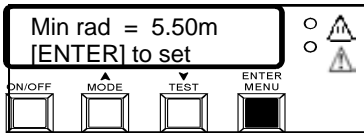

### 11.2 Adjusting the Min Radius Limit

To set a new Min Radius limit, move the equipment to the desired new minimum radius and press ENTER. The radius displayed on the screen represents the current bucket pin position and does not take into account load dimensions. Set the key switch to the LIMIT position to enable limit (If fitted).

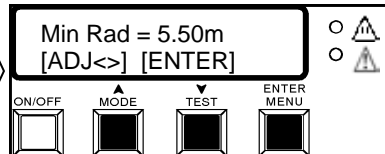
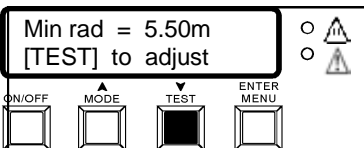

### 11.3 Adjusting the Min Radius Limit manually

To manually enter a radius, press TEST and then use the arrow buttons to set the value. Press ENTER to save. Set the key switch to the LIMIT position to enable limit (If fitted).

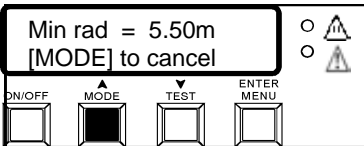

### 11.4 Cancelling the Min Radius limit

Press the MODE button to cancel the current Min Radius limit. Set the key switch to the LIMIT position to enable limit (If fitted).

Confirm that alarms activate and motions cut (If fitted) as required before proceeding.

## 11 Minimum (Cab Protection) Radius Limitation Mode Continued

### 11.5 Minimum Radius limit Alarm State

If the set limit is reached by the bucket pivot pin, a visual warning and alarm will be activated on a basic system. The bucket pivot pin can move through the limit.

With a Combi Box fitted, the arm will only move OUT.

The limit can be overridden by pressing MODE. Select YES, confirm selection by pressing ENTER. Pressing YES will now allow the bucket pivot pin to be moved past the limit. The alarm will continue to sound and two warning messages will be displayed until the bucket pivot pin is 0.5m inside the limit.

Pressing NO will allow the Radius to be either \*cancelled by pressing YES or return to the normal alarm state by pressing NO.

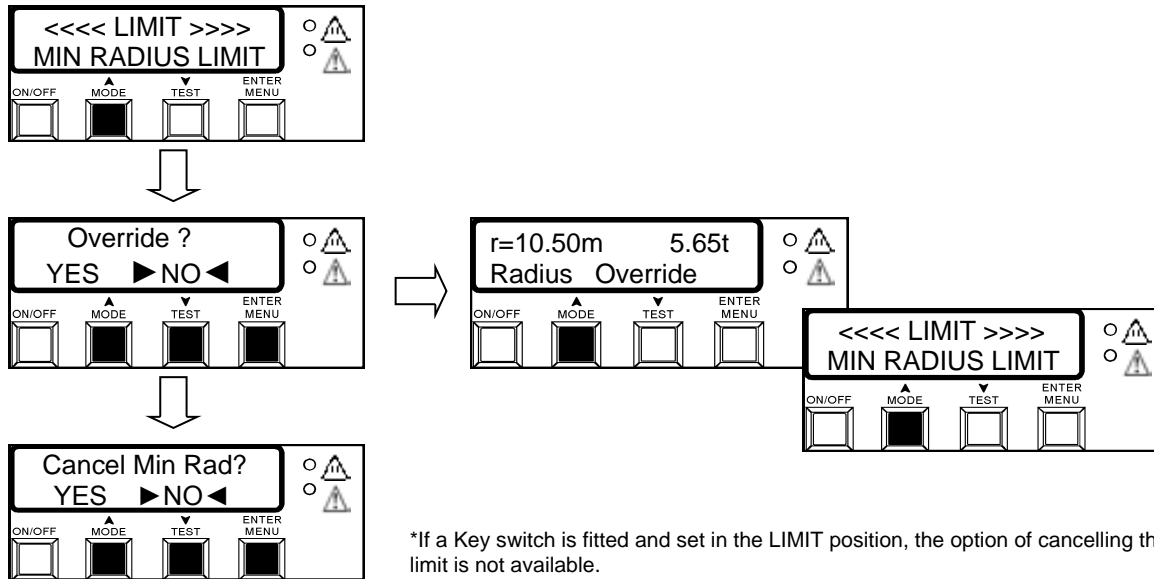



## 12 Duty Selection Mode

The Duty Selection mode will only appear within the general mode cycle if multiple duty selection has been enabled in conjunction with manual duty selection. This forms part of the calibration and set-up of the unit, which is not accessible during normal operation. Multiple duties allow the machine to have more than one lifting duty. On tracked machines this may be used to allow both 360° and OVER FRONT/ REAR lifting arcs for increased lifting capacity, or on wheeled machines it could be used for any combination of arc, support blade and stabiliser usage. Automatic duty switching is available, this can be based on a number of machine features such as slew position, stabiliser position, telescopic extension position, secondary equipment. If idle, this mode will time out and return to RCI mode after 15 seconds.

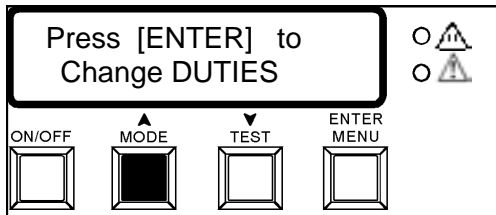

### 12.1

Set the key switch to the SET position if fitted. Use the mode button to cycle through the available modes until the 'change duty' option is displayed. Pressing ENTER will allow adjustment of the current lifting duty. Pressing MODE will continue the mode cycle leaving the current setting unaltered.

If ENTER is pressed, the display shown below will appear.

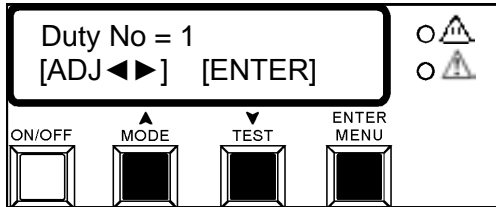

### 12.2

Use the UP & DOWN keys to select the required duty. The load chart issued with the Liftwatch 5 system will list all available lifting duties. There is a maximum of 8 possible duty selections. Press ENTER to confirm the selection. After duty changes are made, control always returns to the Rated Capacity Indicator mode. The new duty number will appear on the right of the lower display line.

### 12.3

Automatic duty switching is available as an option, this can be based on a number of machine features such as slew position, stabiliser position, telescopic extension position, secondary equipment and offset booms. The appropriate duty number is shown on the RCI screen (See section 6) and via the test function (See section 14), the Duty Selection mode is not available when auto duty selection is activated.

### 13 Dig Depth Monitoring Mode

As the Liftwatch 5 system has equipment-mounted angle sensors, it has the capability to measure bucket tooth depth. Although a bucket angle sensor is not a standard feature, careful operation and control of bucket attitude can produce accurate trenching and basement excavations. Use the MODE button to scroll through the options until the display shown below appears. The operation sequence described here gives an example of how the system can be used.

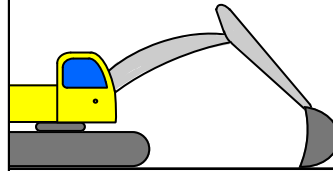
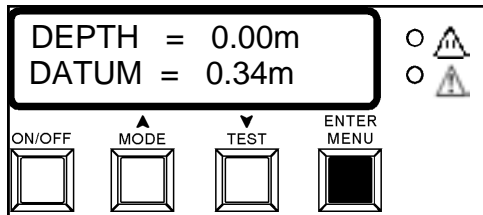

**13.1** Position the bucket on the ground at the start of the excavation, with the bucket in the attitude shown in the diagram. Correct depth will only be displayed when measurements are taken with the bucket in this attitude. This is because Liftwatch 5 system does not have a bucket angle sensor. Press ENTER to set the datum at this elevation. At this point the DEPTH value will change to 0.00, and the new DATUM will become the current ground level.

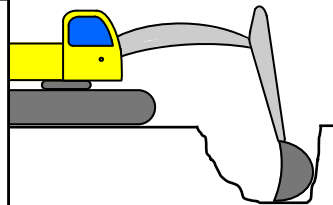
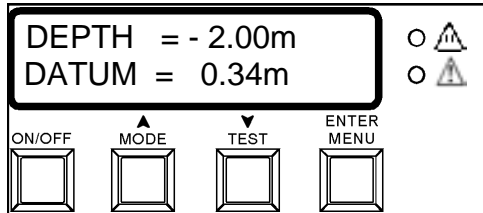

**13.2** Dig to the required depth using the DEPTH value on the top line (remembering that the bucket must be in the attitude described above to measure accurately). In this example the basement depth is 2.00m (or -2.00m below the initial DATUM). NOTE: because the current depth is BELOW the current DATUM, the 'TOO LOW' internal alarm will sound.

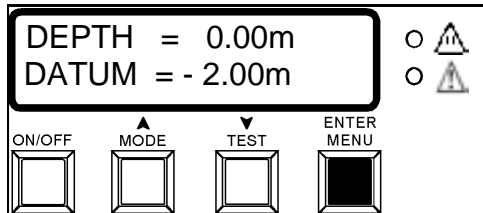

**13.3** Place the bucket (in the attitude described in 1) in the bottom of the trench at the target depth, and press the ENTER button to re-reference the system. The current DEPTH will change to 0.00m (i.e. the distance to the target datum), and DATUM will change to -2.00m (i.e. target depth). The system is now fully referenced and ready for use.

### 13 Dig Depth Monitoring Mode Continued

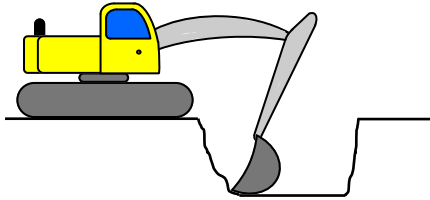

**13.4** The basement/trench can now be extended at will. To extend, move the machine to the new position, place the bucket at the base of the initial excavation, and press the ENTER button to re-reference the position. The excavation can now be continued without the need to watch the display. When the correct depth is achieved (or exceeded) the 'TOO LOW' internal alarm will sound. As the system has been referenced to the bottom of the initial excavation (and not to the track base of the machine) the position/height of the actual excavator is not important.

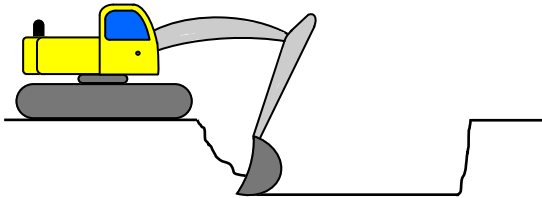

## 14 System Test

The LW5 system has a comprehensive built-in test function that allows the operator to check all aspects of the system and its set-up. This function can be accessed at any time from either the Time & Date mode, Rated Capacity Indicator mode, or the Dig Depth monitoring mode, by pressing the TEST button. If a key switch is fitted, it must be in the SET position and the time and date mode displayed to enter the test function. Once this mode is accessed, pressing TEST will cycle the options available and pressing MODE will cancel the function and return to the previous operational mode. This mode will time out and return to normal operating mode after one minute.

If a problem arises with the Liftwatch 5, use this feature to test the affected function / components, knowledge of this function will greatly assist our service staff with initial telephone support if required.

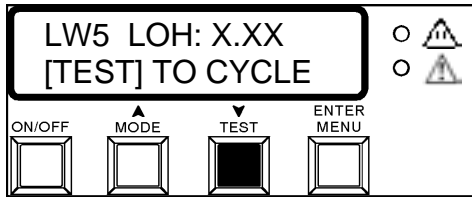

The initial test display is shown here. All information is displayed on the upper line. The lower line contains a scrolling message that says '[TEST] to cycle [MODE] to exit'. This will be present throughout the test procedure.

### Software version number

The software version (VX.XX) shown is the internal software version. When requesting service support, always quote this number.

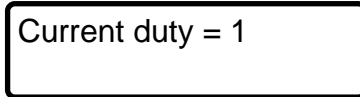

### Current duty number

This displays the current lifting duty selected.

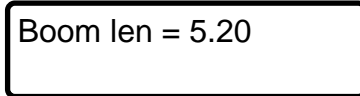

### Boom length

This is the straight line distance between the boom pivot pin and arm pivot pin, and is given in metres.

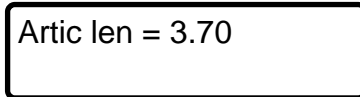

### Artic length

This is the length of the secondary boom section on an hydraulically adjustable boom. If the system is configured for monoboam equipment, this display will not appear. The length is the straight line distance between the secondary boom pivot pin and the arm pivot pin, and is given in metres.

## 14 System Test Continued

Arm len = 2.80

**Arm length**

This is the straight line distance between the arm pivot pin and bucket pivot pin, and is given in metres.

Beacon ON check

**Beacon check**

If the system has a COMBI BOX (see Liftwatch 5 Hardware Guide) and the magnetically-mounted beacon is correctly attached, this test will activate the beacon.

Alarm ON check

**Alarm check**

This test will activate the external alarm.

Buzzer ON check

**Internal alarm check**

This test will activate the internal alarm which is mounted on the rear of the display housing.

Amber LED check

**Amber LED check**

This test will activate the amber LED on the display front.

Red LED check

**Red LED check**

This test will activate the red LED on the display front.

## 14 System Test Continued

Pressure= 125.2

### Pressure check

This test will display the current pressure (in BARS) measured in the PISTON SIDE of the boom lift cylinder(s).

Boom Ang= 32.1°

### Boom angle check

This test displays the current boom angle on monoboam machines, or the first boom section angle on hydraulically adjustable boom machines. The angle given is for the imaginary line connecting the two pivot pins. As the boom moves up the value should increase: as the boom moves down the value should decrease. When the two pins are in the same horizontal plane, the value should be zero.

Arm Ang= 90.6°

### Arm angle check

This test displays the current arm angle in degrees. The angle given is for the imaginary line connecting the two pivot pins. As the arm moves out the value should decrease: as the arm moves in the value should increase. When the two pins are in same vertical plane, the value should be 90.

Artic Ang= 12.8°

### Artic angle check

This test displays the current secondary boom angle on hydraulically adjustable boom machines. The angle given is for the imaginary line connecting the two pivot pins. As the secondary boom moves up the value should increase: as the secondary boom moves down the value should decrease. When the two pins are in same horizontal plane, the value should be zero. This option will not appear on monoboam machines.

15:53      26/06/08

### Calibration time and date

The final test option displays the calibration time and date. This value is updated when the passcode protected Calibration menu is accessed.

## 15 Setting the Clock

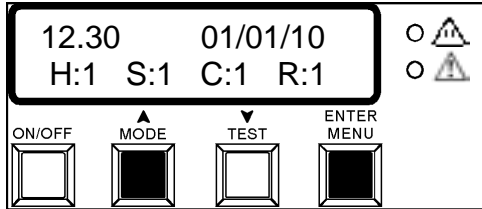

To access the clock setting function, the Liftwatch 5 system must be switched on and operating in the Time & Date mode. This mode is not available if RCI only mode has been activated (See section 6).

Press the MODE and ENTER buttons together. The display will now enter the clock set function as described below.

As each parameter is offered, use the UP and DOWN keys to adjust the displayed number to the correct value, and press ENTER to confirm. At the end of the procedure control will return to the normal Time & Date mode.

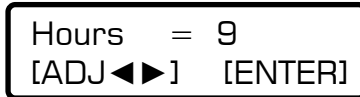

HOURS range = 0 to 23

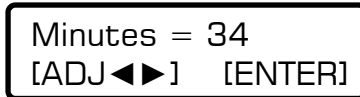

MINUTES range = 0 to 59

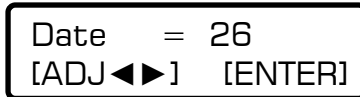

DATE range = 1 to 31 (Note : it is possible to set a date beyond the maximum—for example 31 February. If this is attempted the system will set itself to the next valid date and month).

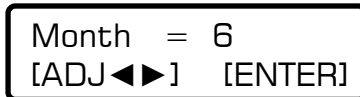

MONTH range = 1 to 12 (1 = January, 12 = December)

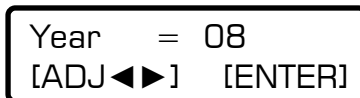

YEAR range = 00 to 99 (00 = 2000)

## 16 Setting Screen Contrast

To adjust the contrast on the LW5 screen, press the TEST and ENTER together in the time and date mode. Use the UP/DOWN buttons to adjust. Press ENTER to save the desired contrast.

This mode is not available if RC1 only mode has been activated (See section 6).

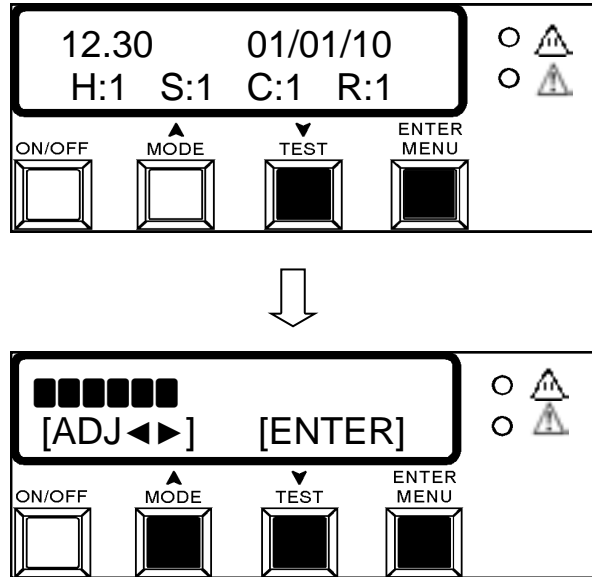



## 17 Error Conditions

During initial system power-up and during normal operation, the Liftwatch 5 software checks for the presence and 'health' of all attached components. Each component (e.g. an angle sensor etc) is queried by the cab mounted display unit and given 1 second in which to respond. Any component that fails to respond within this period is deemed to have failed. Any failed component will generate a unique message shown below. The lower display line will alternate between the offending component or components. This will indicate if the sensor is missing, damaged, or that there is a fault with interconnecting CAN bus cable. If an error condition is displayed, halt any operation, seek service immediately and do not continue operation until the fault has been remedied. The test function (see section 14) can be used for further diagnostics.

r=10.50m    5.65t  
>>> OVERRIDE<<<

If a Combi Box or Single Motion Cut Box is fitted (See section 1), it is possible to override the unit if it has failed by turning the Override key on it's lid. If the Combi Box is overridden, the message OVERRIDE will appear on the lower section of the screen. A Single Motion Cut Box, in override, will NOT produce any warning. The LW5 should no longer be used, halt any operation, seek service immediately and do not continue operation until the fault has been remedied. This feature is to allow the machine to be moved for service/ repair purposes only. Any limits set are no longer monitored and visual warning, alarm or motion cuts will not occur if any limit is reached in this state.

r=10.50m    5.65t  
! BOOM FAILED

Boom sensor not detected.

r=10.50m    5.65t  
! ARTIC FAILED

Artic sensor not detected.

r=10.50m    5.65t  
! ARM FAILED

Arm sensor not detected.

r=0.50m      5.65t  
! COMBI FAILED

Combi box not detected.

r=10.50m    5.65t  
! RELAY POWER

Power not detected to Combi Box relays.

## 18 System Diagrams - Base System

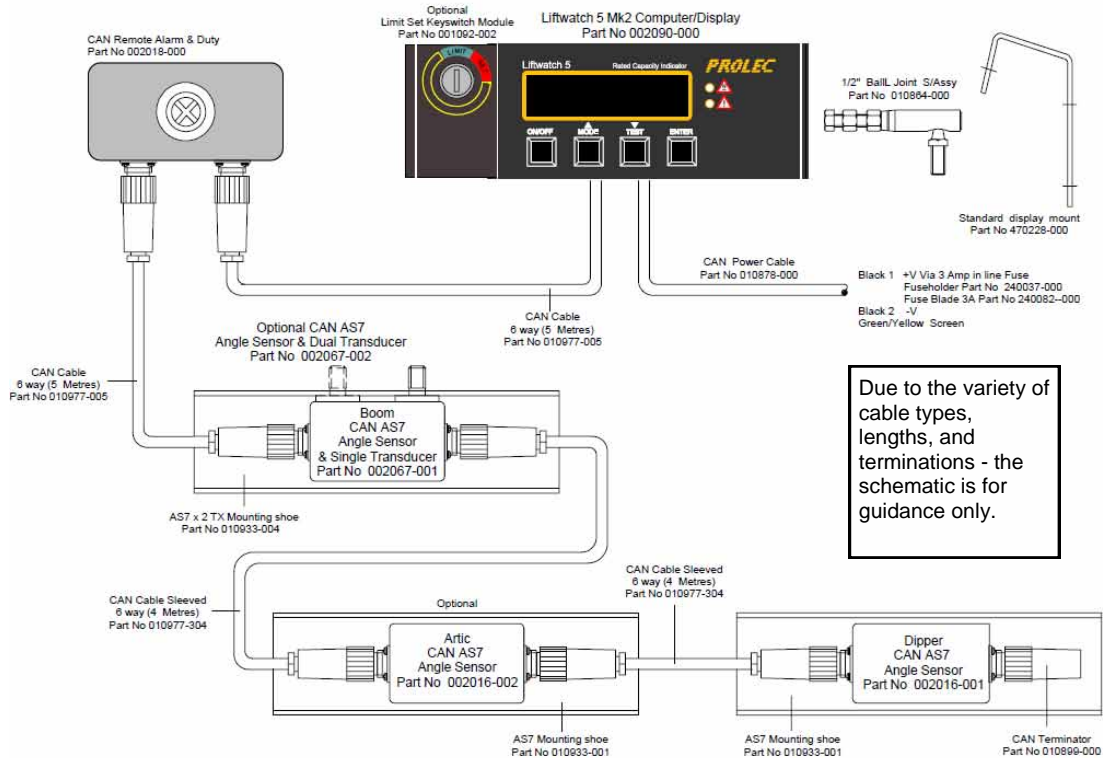

## 18 System Diagrams - 4 Way Combi System

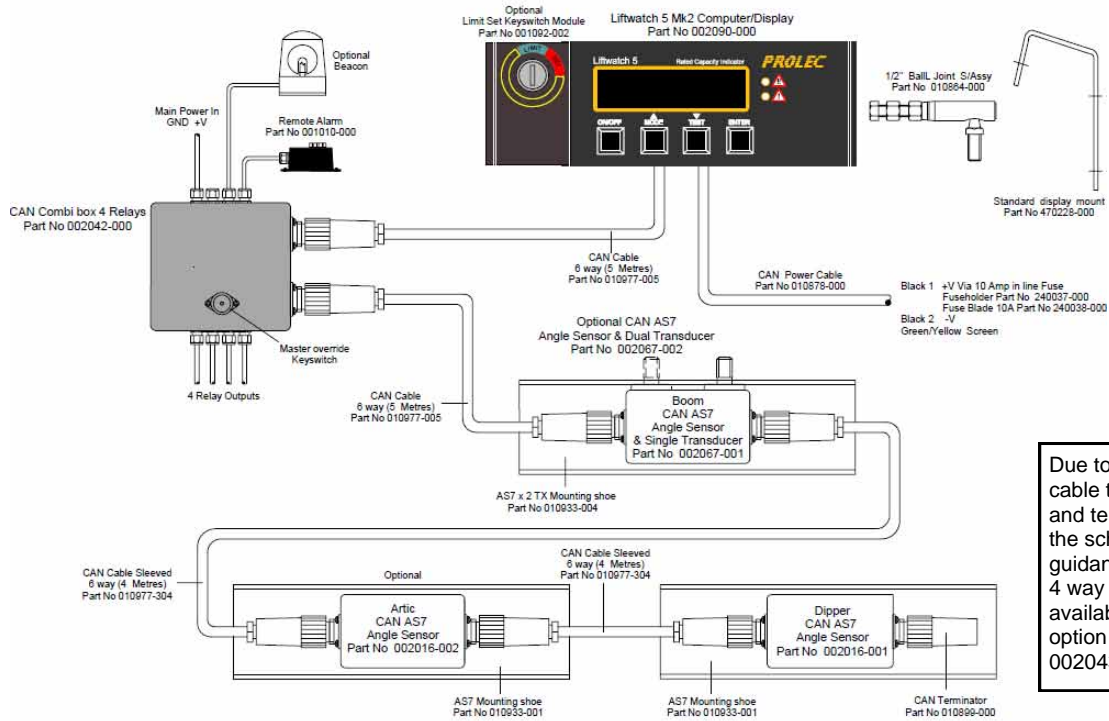

Due to the variety of cable types, lengths, and terminations - the schematic is for guidance only. 4 way Combi box available with slew option Part Number 002043-000

## 18 System Diagrams - 8 Way Combi System

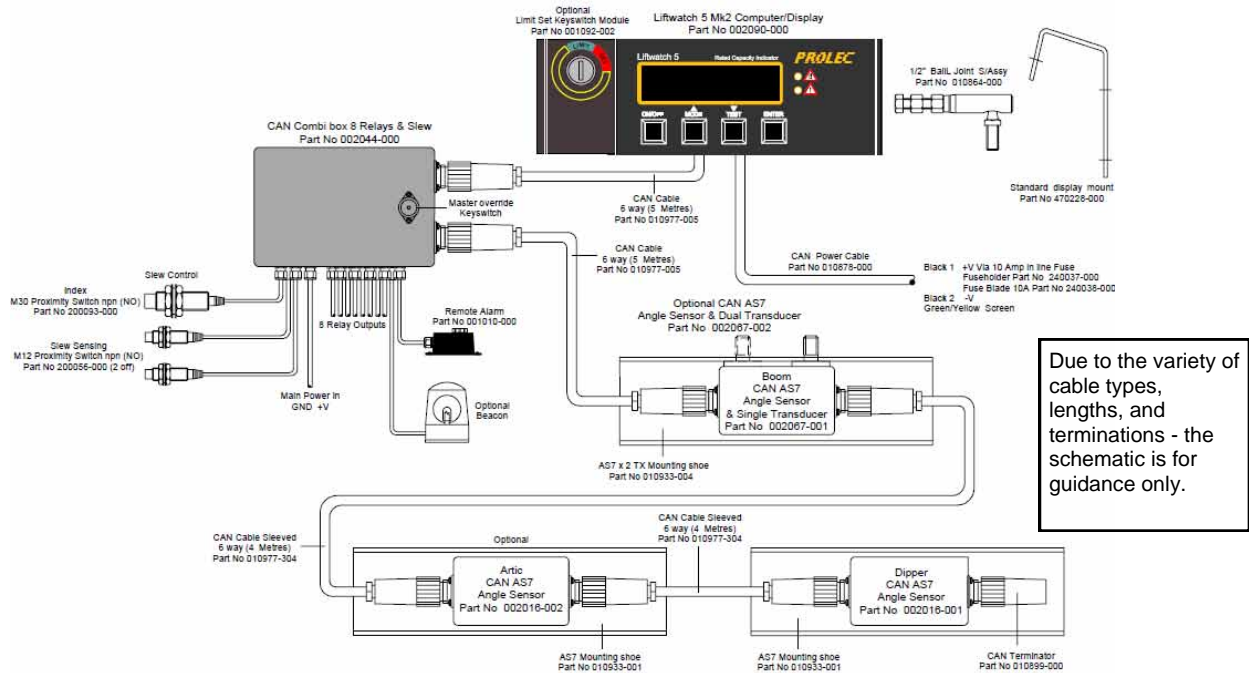

## **19 Daily Checks**

### **Visual Check To be carried out Daily**

- Exposed proximity switches for slew monitor and slew reference switches (If fitted)- check for damage
- Sensors and sensor cabling - check for damage
- Connectors - check for damage
- Display - check for damage and any operational abnormalities





PROLEC LTD  
25 BENSON ROAD  
NUFFIELD INDUSTRIAL ESTATE  
POOLE, DORSET  
ENGLAND, BH17 0GB

560361-006 Issue 1.2



+44 (0)1202 681190



+44 (0)1202 677909



[service@prolec.co.uk](mailto:service@prolec.co.uk)